

ADEGO

SCRAPER SYSTEMS

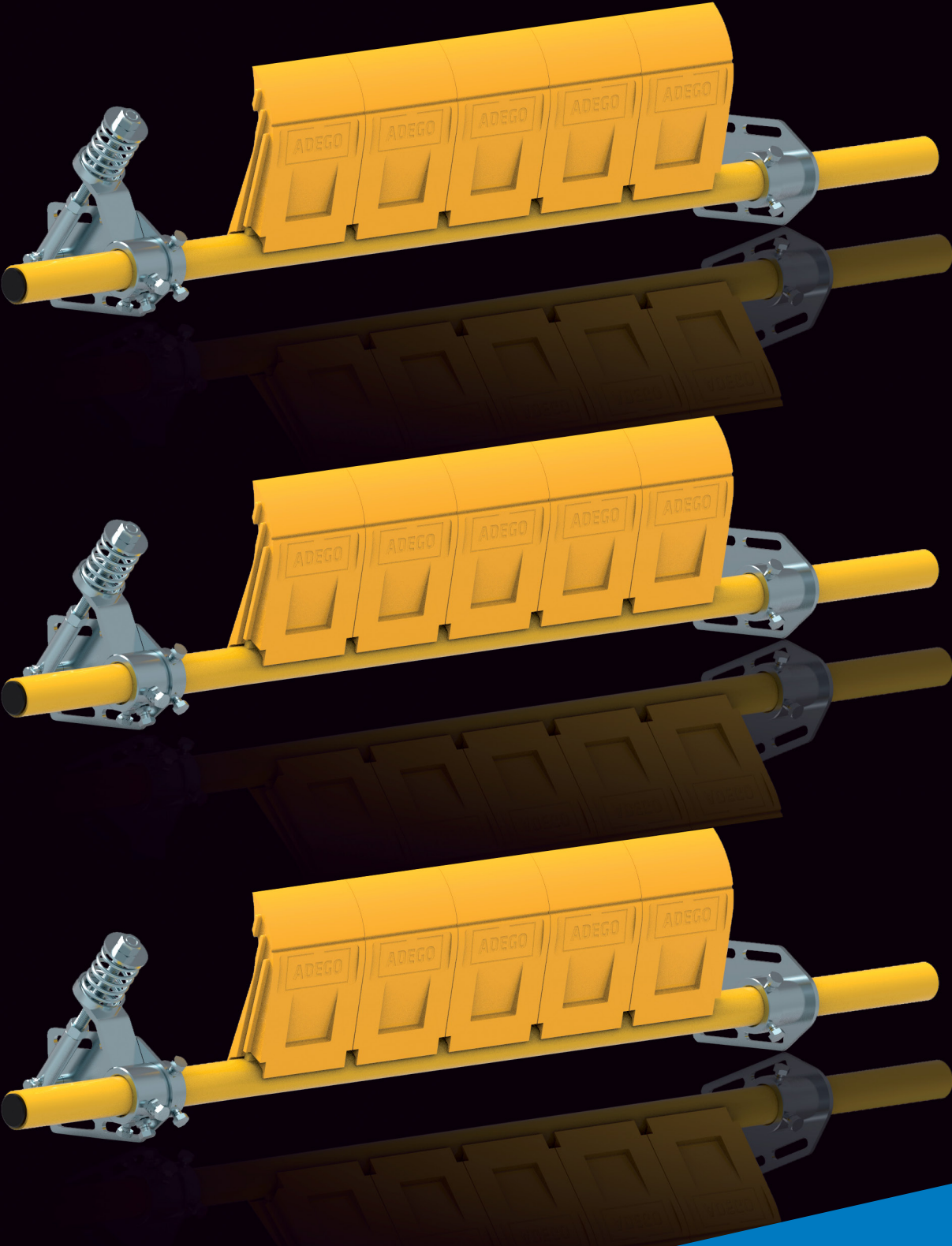

www.adegogroup.com

Secondary belt scraper

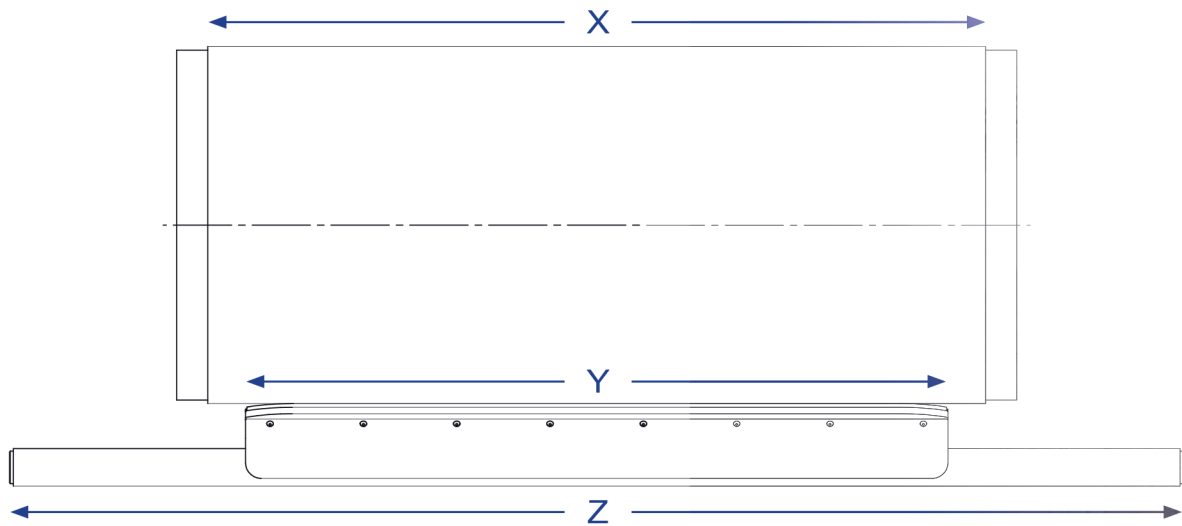

Primary belt cleaner

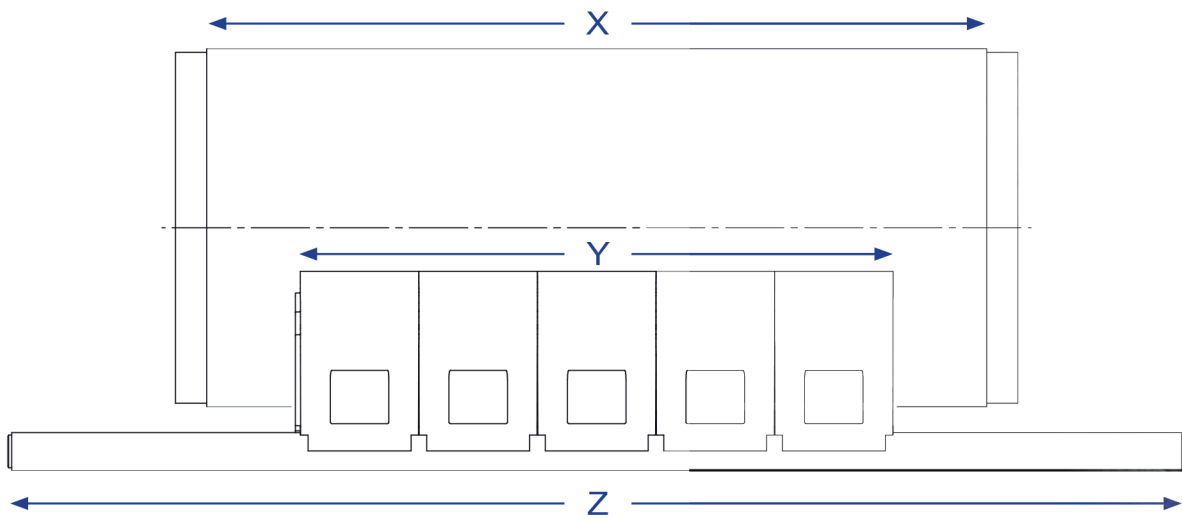

Internal belt cleaner

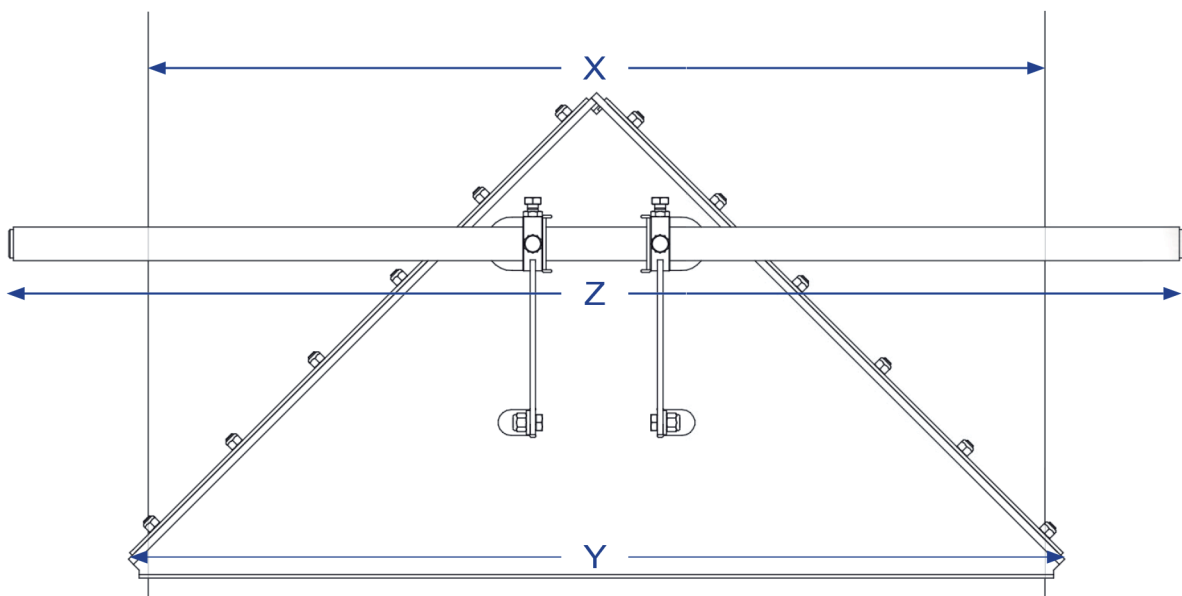

Adego Prime 45°

Vmax: 3.0 m/sec.
-100°C/ +200°C

Vmax: 3.5 m/sec.
-20°C/ +70°C
BB: 200mm-3000mm

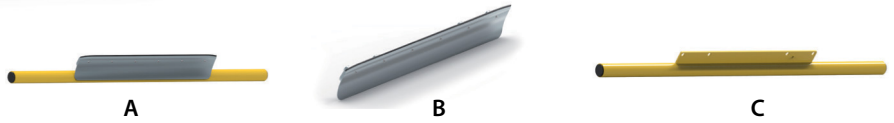
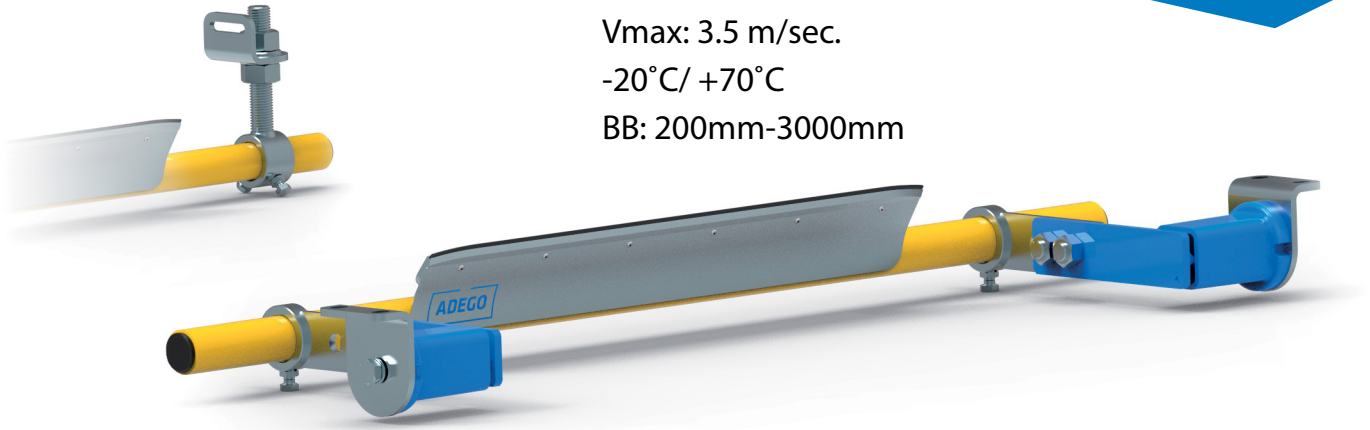

	X	Y	Z	A	B	C
ø 48	400	350	1000	001-001-350/45°	001-002-350/45°	001-003-400/48°
	500	450	1000	001-001-450/45°	001-002-450/45°	001-003-500/48°
	650	550	1200	001-001-550/45°	001-002-550/45°	001-003-650/48°
	650	600	1200	001-001-600/45°	001-002-600/45°	001-003-650/48°
	800	700	1300	001-001-700/45°	001-002-700/45°	001-003-800/48°
	800	750	1300	001-001-750/45°	001-002-750/45°	001-003-800/48°
	1000	900	1500	001-001-900/45°	001-002-900/45°	001-003-1000/48°
	1000	950	1500	001-001-950/45°	001-002-950/45°	001-003-1000/48°
ø 60	1200	1050	1700	001-001-1050/45°	001-002-1050/45°	001-003-1200/60°
	1200	1125	1700	001-001-1125/45°	001-002-1125/45°	001-003-1200/60°
	1400	1200	1900	001-001-1200/45°	001-002-1200/45°	001-003-1400/60°
	1400	1300	1900	001-001-1300/45°	001-002-1300/45°	001-003-1400/60°
	1600	1400	2100	001-001-1400/45°	001-002-1400/45°	001-003-1600/60°
	1600	1500	2100	001-001-1500/45°	001-002-1500/45°	001-003-1600/60°
	1800	1600	2300	001-001-1600/45°	001-002-1600/45°	001-003-1800/60°
	1800	1700	2300	001-001-1700/45°	001-002-1700/45°	001-003-1800/60°
ø 70	2000	1800	2500	001-001-1800/45°	001-002-1800/45°	001-003-2000/70°
	2000	1900	2500	001-001-1900/45°	001-002-1900/45°	001-003-2000/70°

D	E	F	G	H	I	J
050-001-300-650	050-005-300-650	050-003-400-650	050-004-400-650	050-009-M24	050-010-M24	050-011-M24
050-001-800-1000	050-005-800-1000	050-003-800-1000	050-004-800-1000	050-009-M30	050-010-M30	050-011-M30
050-001-1200-1600	050-005-1200-1600	050-003-1200-1600	050-004-1200-1600	050-009-M36	050-010-M36	050-011-M36
050-001-1800-2200	050-005-1800-2200	050-003-1800-2200	050-004-1800-2200	050-009-M42	050-010-M42	050-011-M42

Adego Prime 90°

Vmax: 3.0 m/sec.
-100°C/ +200°C

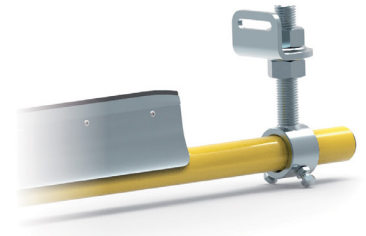

Vmax: 3.5 m/sec.
-20°C/ +70°C
BB: 200mm-3000mm

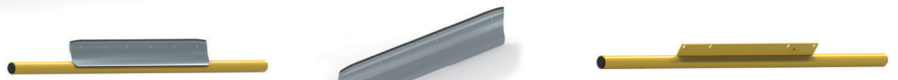
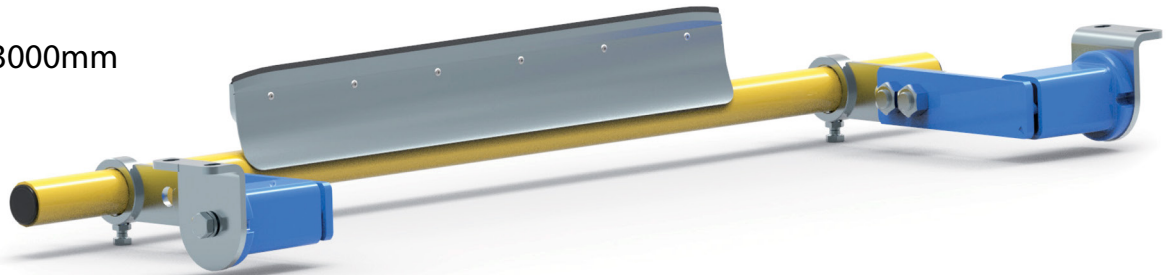

	X	Y	Z	A	B	C
ø 48	400	350	1000	001-001-350/90°	001-002-350/90°	001-003-400/48°
	500	450	1000	001-001-450/90°	001-002-450/90°	001-003-500/48°
	650	550	1200	001-001-550/90°	001-002-550/90°	001-003-650/48°
	650	600	1200	001-001-600/90°	001-002-600/90°	001-003-650/48°
	800	700	1300	001-001-700/90°	001-002-700/90°	001-003-800/48°
	800	750	1300	001-001-750/90°	001-002-750/90°	001-003-800/48°
	1000	900	1500	001-001-900/90°	001-002-900/90°	001-003-1000/48°
	1000	950	1500	001-001-950/90°	001-002-950/90°	001-003-1000/48°
ø 60	1200	1050	1700	001-001-1050/90°	001-002-1050/90°	001-003-1200/60°
	1200	1125	1700	001-001-1125/90°	001-002-1125/90°	001-003-1200/60°
	1400	1200	1900	001-001-1200/90°	001-002-1200/90°	001-003-1400/60°
	1400	1300	1900	001-001-1300/90°	001-002-1300/90°	001-003-1400/60°
	1600	1400	2100	001-001-1400/90°	001-002-1400/90°	001-003-1600/60°
	1600	1500	2100	001-001-1500/90°	001-002-1500/90°	001-003-1600/60°
	1800	1600	2300	001-001-1600/90°	001-002-1600/90°	001-003-1800/60°
	1800	1700	2300	001-001-1700/90°	001-002-1700/90°	001-003-1800/60°
ø 70	2000	1800	2500	001-001-1800/90°	001-002-1800/90°	001-003-2000/70°
	2000	1900	2500	001-001-1900/90°	001-002-1900/90°	001-003-2000/70°

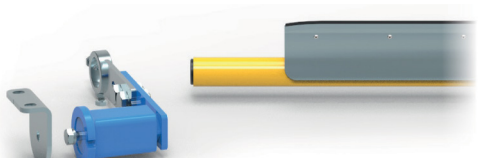

050-001-300-650	050-005-300-650	050-003-400 – 650	050-004-400 – 650	050-009-M24	050-010-M24	050-011-M24
050-001-800-1000	050-005-800-1000	050-003-800 – 1000	050-004-800 – 1000	050-009-M30	050-010-M30	050-011-M30
050-001-1200-1600	050-005-1200-1600	050-003-1200 – 1600	050-004-1200 – 1600	050-009-M36	050-010-M36	050-011-M36
050-001-1800-2200	050-005-1800-2200	050-003-1800 – 2000	050-004-1800 – 2000	050-009-M42	050-010-M42	050-011-M42

Adego Prime 45°/90°

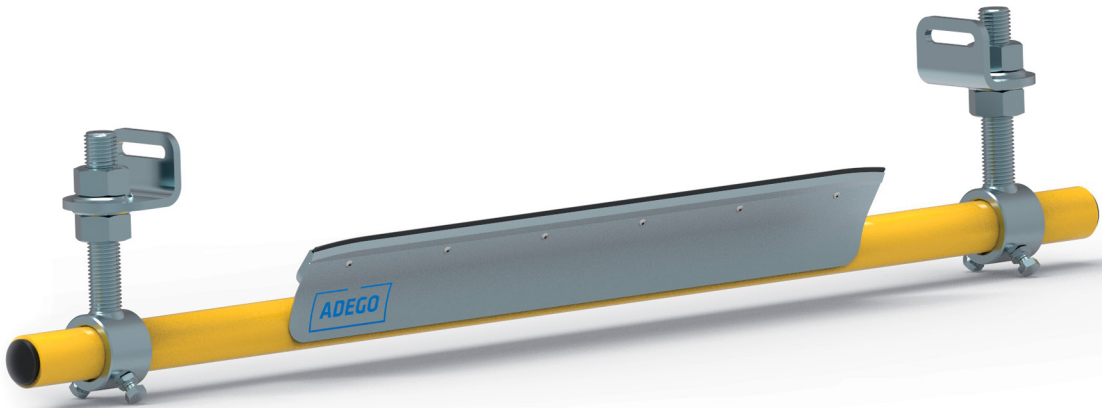

X	S1	A	B1	B2	C
400 – 650 mm 800 – 1000 mm	M 24 x 160 mm M 30 x 160 mm	Ø 48 mm	58 mm	82 mm	150 – 200 mm 200 – 300 mm
1200 – 1800 mm 2000 – 2600 mm	M 36 x 200 mm M 42 x 200 mm	Ø 60 mm Ø 70 mm	65 mm	95 mm	~ 300 mm

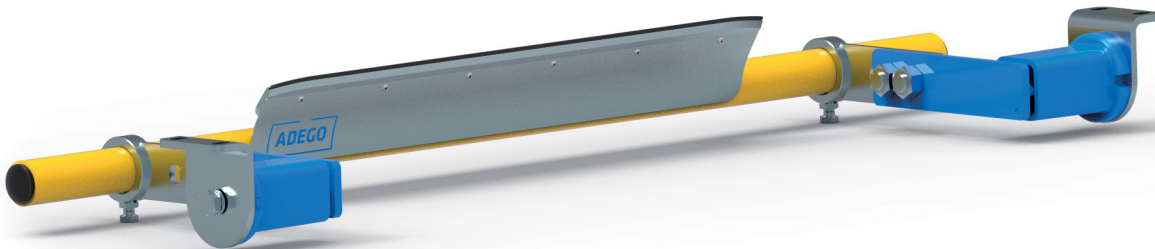
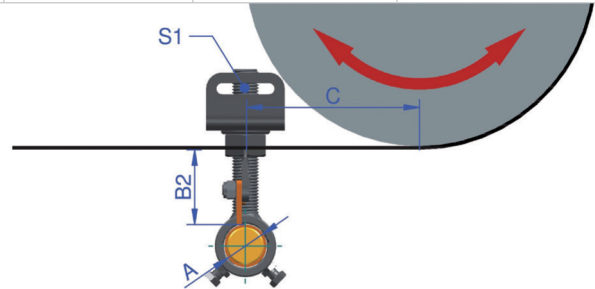
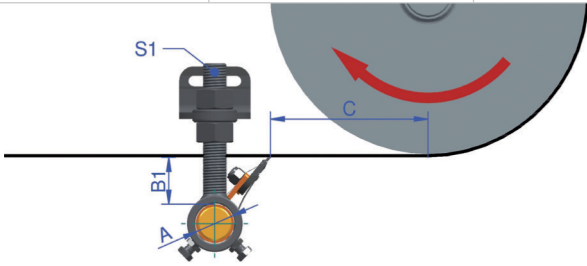

X	S2	A	B1	B2	C	D
400 – 650 mm 800 – 1000 mm	SE-27 SE-38	Ø 48 mm	58 mm	82 mm	100 – 200 mm 120 – 200 mm	250 mm 290 mm
1200 – 1600 mm 1800 – 2200 mm	SE-38 SE-45	Ø 60 mm Ø 70 mm	65 mm	95 mm	150 – 250 mm	298 mm 360 mm

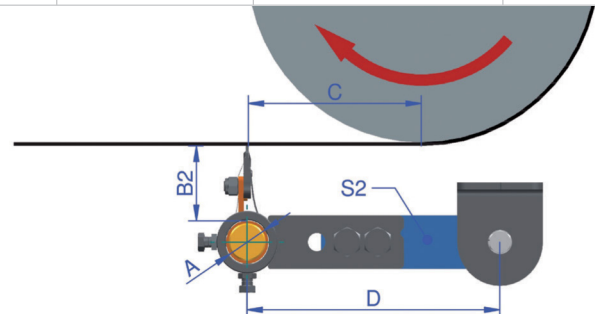
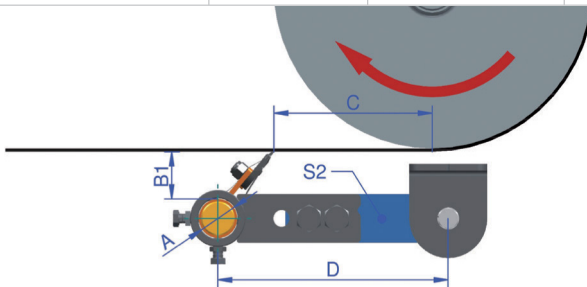

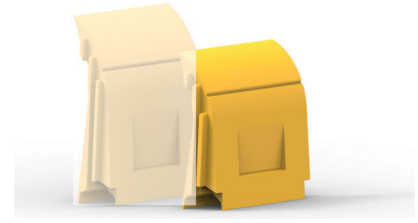

Adego S

Vmax: 3.5 m/sec.
 -30°C/ +80°C
 BB: 200mm-2000mm

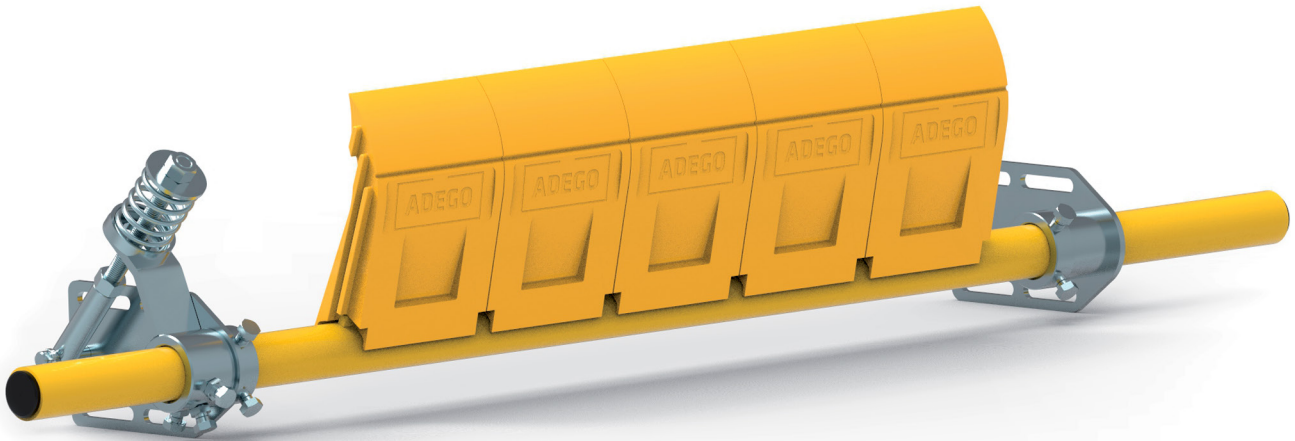

Adego M Adego S



	X	Y	Z	A	B
ø 48	400	300	1000	006-001-300	006-002-150
	500	300	1000	006-001-300	
	650	450	1200	006-001-450	
	800	600	1300	006-001-600	
	1000	750	1500	006-001-750	
ø 60	1200	900	1700	006-001-900	
	1400	1050	1900	006-001-1050	
	1600	1200	2100	006-001-1200	
	1600	1350	2100	006-001-1350	
	1800	1500	2300	006-001-1500	
	1800	1650	2300	006-001-1650	



	X	S
BB 400 – 1000 (dia 48)		050-020-48
BB 1200 – 1400 (dia 60)		050-020-60
BB 1600 – 1800 (dia 60)		050-021-60

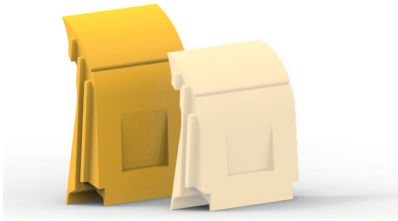



Adego M Adego S

Vmax: 3.5 m/sec.

-30°C/ +80°C

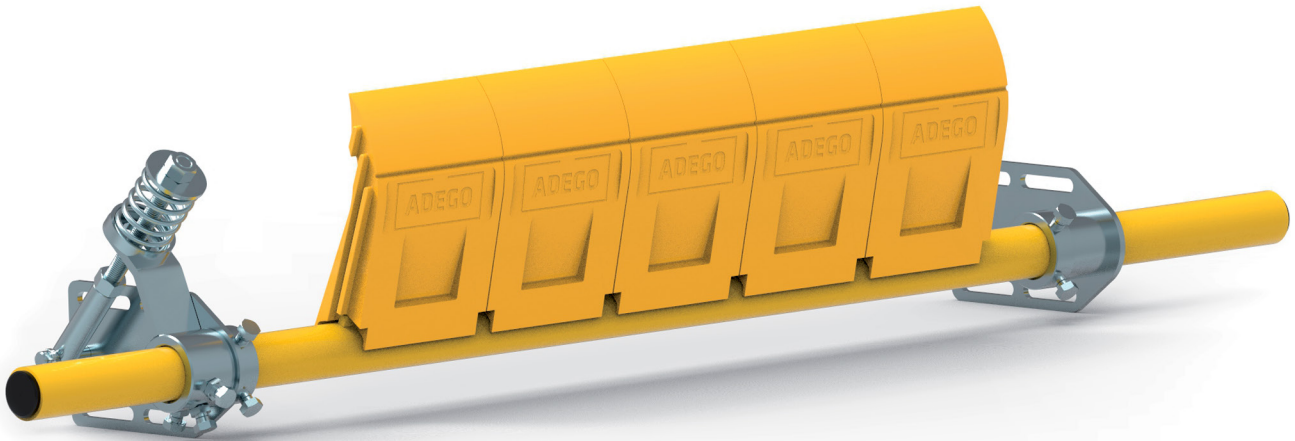
BB: 200mm-2000mm



	X	Y	Z	A	B
ø 48	400	300	1000	005-001-300	005-002-150
	500	400	1000	005-001-300	
	650	450	1200	005-001-450	
	800	600	1300	005-001-600	
	1000	750	1500	005-001-750	
ø 60	1200	900	1700	005-001-900	
	1400	1050	1900	005-001-1050	
	1600	1200	2100	005-001-1200	
	1600	1350	2100	005-001-1350	
	1800	1500	2300	005-001-1500	
	1800	1650	2300	005-001-1650	



S

X	S
BB 400 – 1000 (dia 48)	050-020-48
BB 1200 – 1400 (dia 60)	050-020-60
BB 1600 – 1800 (dia 60)	050-021-60

Adego S / M

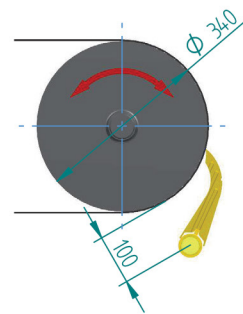
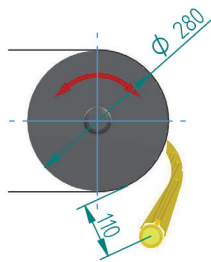
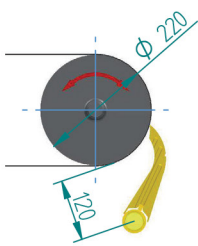
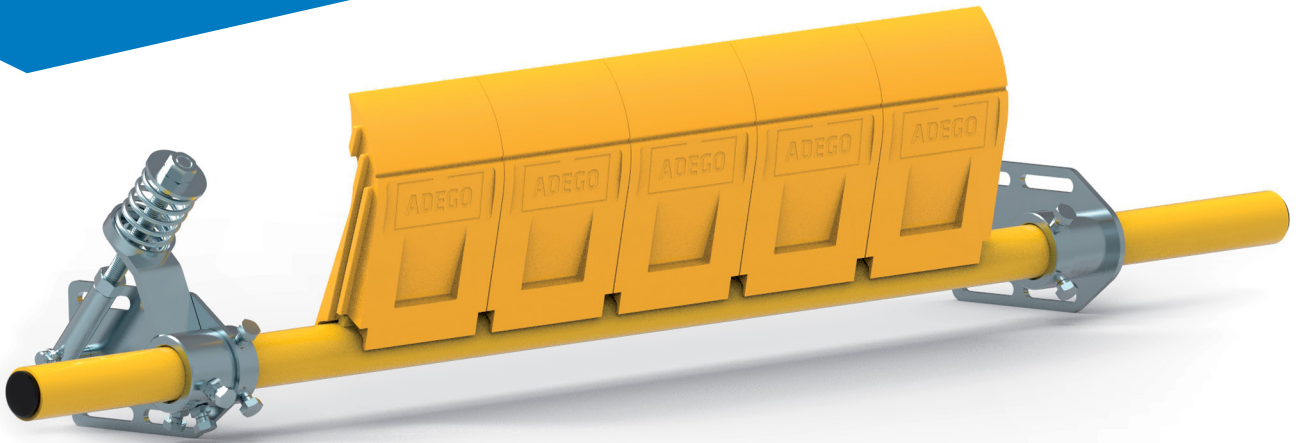

Adego S

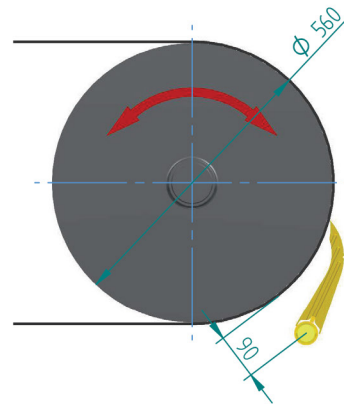
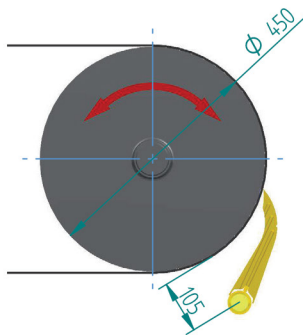
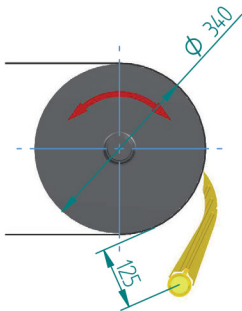

Adego M

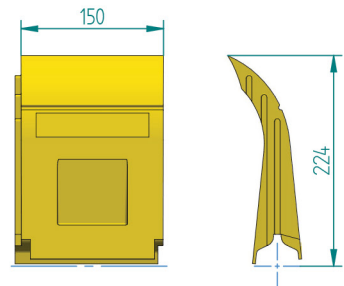
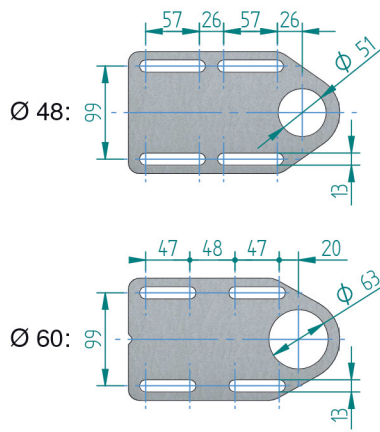
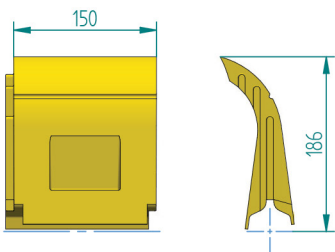

Adego S

Adego M

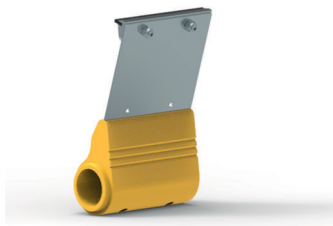

Vmax: 3 m/sec.
 -30°C/ +80°C
 BB: 200mm-2000mm

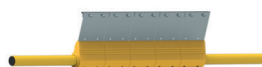
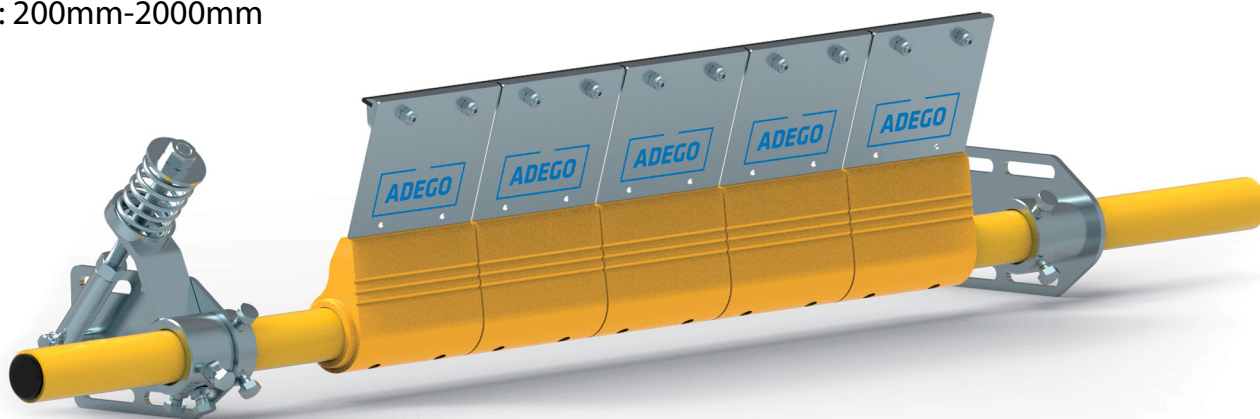

	X	Y	Z	A	B	C
ø 48	500	300	1000	004-001-300	004-003-150/1	004-002-150/1
	650	450	1200	004-001-450		
	800	600	1300	004-001-600		
	1000	750	1500	004-001-750		
	1200	900	1700	004-001-900		
	1400	1050	1900	004-001-1050		
	1600	1200	2100	004-001-1200		
	1600	1350	2100	004-001-1350		
	1800	1500	2300	004-001-1500		
	1800	1650	2300	004-001-1650		

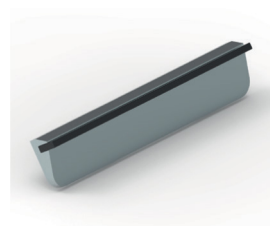

	X	S
	BB 400 – 1000 (dia 48)	050-020-48
	BB 1200 – 1400 (dia 60)	050-020-60
	BB 1600 – 1800 (dia 60)	050-021-60

Adego W

Vmax: 3 m/sec.
 -30°C/ +80°C
 BB: 400mm-1600mm

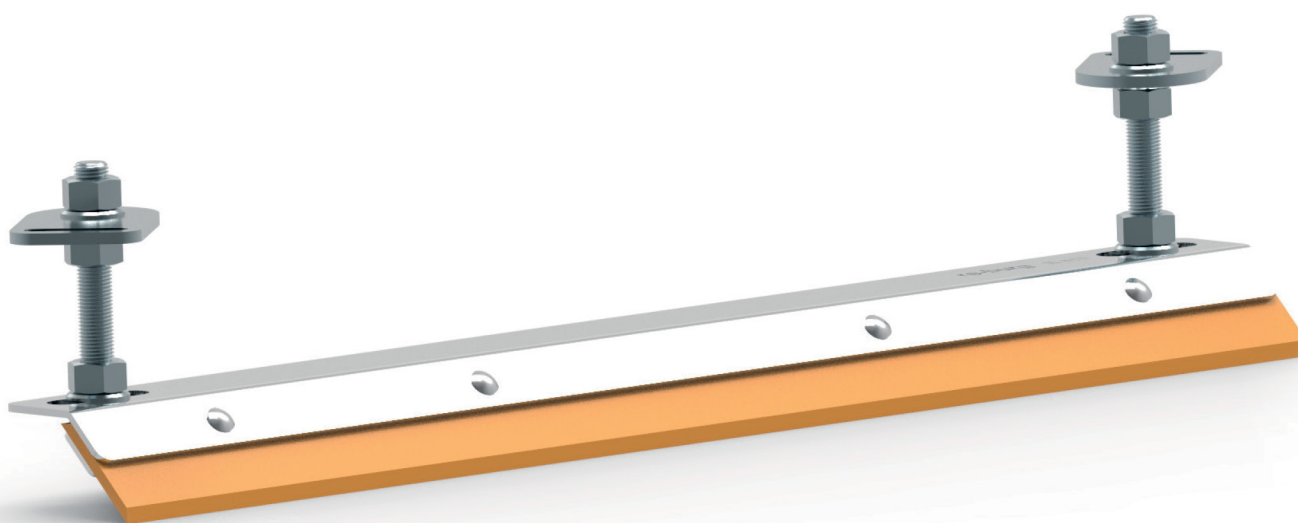

X	Y	A	B
400	450	002-001-400	002-002-400
500	550	002-001-500	002-002-500
650	700	002-001-650	002-002-650
800	850	002-001-800	002-002-800
1000	1050	002-001-1000	002-002-1000
1200	1250	002-001-1200	002-002-1200
1400	1450	002-001-1400	002-002-1400
1600	1650	002-001-1600	002-002-1600

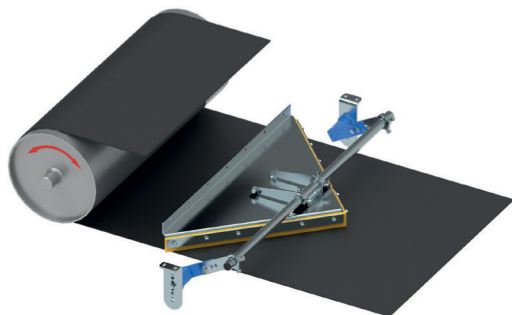

Vmax: 3 m/sec.
 -30°C/ +80°C
 BB: 400mm-1600mm

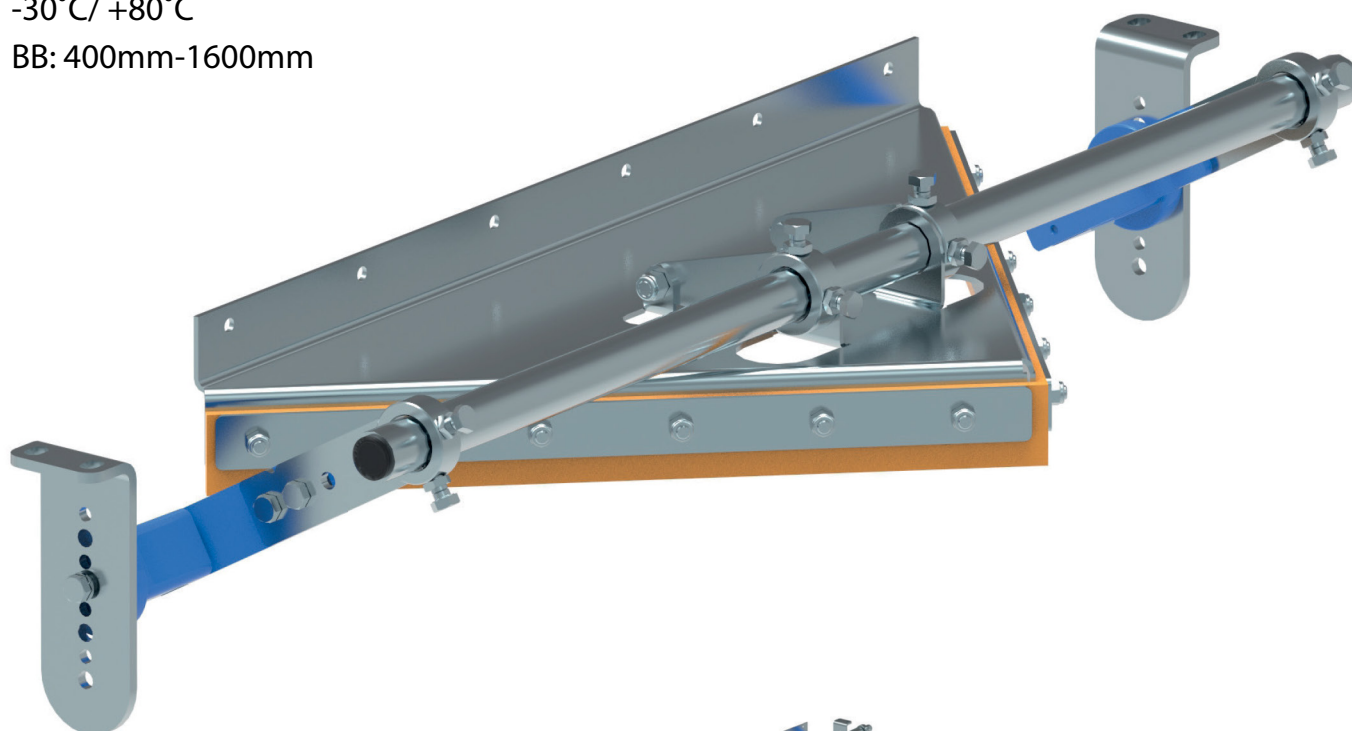

	X	Y	Z	A	B
∅ 38	400	450	1000	007-001-400	007-002-400
	500	550	1000	007-001-500	007-002-500
	650	700	1200	007-001-650	007-002-650
	800	850	1300	007-001-800	007-002-800
	1000	1050	1500	007-001-1000	007-002-1000
	1200	1250	1700	007-001-1200	007-002-1200
	1400	1450	1900	007-001-1400	007-002-1400
	1600	1650	2100	007-001-1600	007-002-1600

Adego Group

Krustpils street 64,
Riga, Latvia

+371 22338070
+371 20463626

info@adegogroup.com